

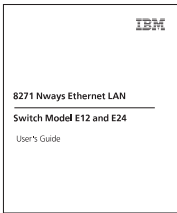

8271 NWAYS ETHERNET LAN SWITCH MODELS E12 AND E24 QUICK INSTALLATION GUIDE

Package Contents



User's Guide



8271 Model E12 (02L0876)
8271 Model E24 (02L0877)

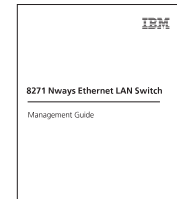

Management
Guide



Quick Reference Guide



Release Notes

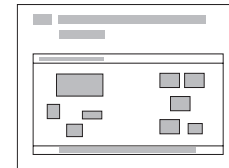

Quick Installation
Guide

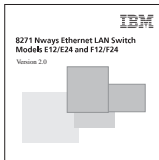

CD-ROM

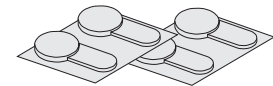

4 x rubber feet

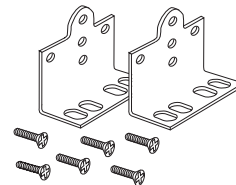

2 x mounting brackets and 6 x fixing

Installing the Switch



DANGER:  SD21-0030.

The User's Guide also contains further information on the following steps.

Installing into a 19-inch Rack

Fit the brackets as shown in the figure below to each side of the unit. Following the manufacturer's instructions, secure the unit into the rack.



You must use the screws supplied with the mounting brackets. Damage caused to the unit by using incorrect screws will invalidate your warranty.

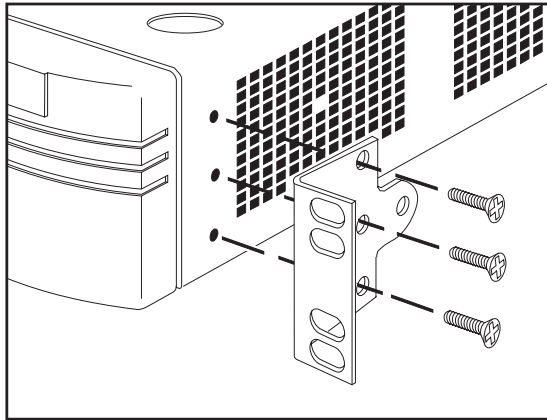

Powering-up the Switch

- 1 Plug the power cord into the power socket at the rear of the Switch.
- 2 Plug the other end of the power cord into your power outlet.



DANGER: It is essential that the mains socket outlet is installed near to the unit and is accessible. You can only disconnect the unit by removing the appliance coupler from the unit.

The Switch powers-up and runs through its Power On Self Test (POST), which takes approximately 12 seconds. When the POST is complete, check the Power/Self Test LED to see that your Switch is operating correctly.

Color	State
Green	The Switch is powered-up and operating normally.
Yellow	The Switch has failed its POST.
Off	The Switch is not receiving power.

Further Information

- You can find further information about installing and powering-up the Switch in the "IBM 8271 Nways Ethernet LAN Switch Model E12 and E24 User's Guide".
- For information about setting up the Switch for management, refer to Chapter 2 of the IBM Nways Ethernet LAN Switch Management Guide.